

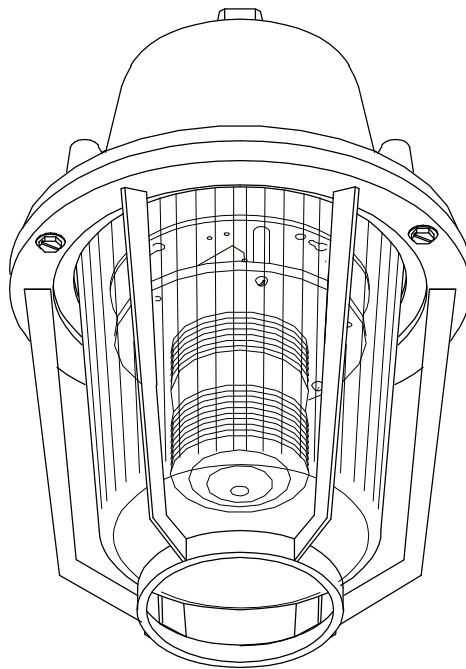

Lighting Products

- CSA - Class I Div. 2 - Groups A, B, C & D
- CSA - Type 3R enclosure



## ***HX-Strobe***

### ***Hazardous Area Xenon Strobe Fixture***

#### **Features:**

- **Medium intensity flashboard** provides **2 million peak candlepower** and is factory set at 60 FPM.
- **Electronic flashboards** are available in four **AC and DC voltages**.
- **Inner fresnel lens** provides maximum light concentration and is available in **five colors**.
- **Compact design** for use in areas with size restrictions.
- **Cast aluminum housing and mounts**.
- **Polyester powder coat finish** and stainless steel external hardware for corrosion resistance.
- Prismatic, **heat and impact resistant**, tempered glass **globe**.
- **Four mounting styles** available: (pendant, ceiling, wall and 25° stanchion).
- Optional **cast aluminum guard** for maximum globe protection.

#### **Applications:**

- |                                       |                                  |
|---------------------------------------|----------------------------------|
| ■ Toxic materials handling facilities | ■ Waste treatment plants         |
| ■ Remote gas compressor buildings     | ■ Marine loading terminals       |
| ■ Pipeline pumping stations           | ■ Emergency evacuation signaling |
| ■ Refineries                          | ■ Chemical manufacturing plants  |

# HX-Strobe

## Catalog Number

**HX** **M** **1** **R** - **G** - **B2**  
 (1) (2) (3) (4) (5) (6)

**(1) Series - "HX"**

Hazardous area Xenon strobe fixture.

**(2) Flashboard - Lamp Type (Xenon)**

**M** - Medium intensity 2 million candlepower  
 (flashrate 60 FPM)

**(3) Voltage / Frequency**

- 1** - 120 Volt AC, 50 / 60 Hz.
- 2** - 240 Volt AC, 50 / 60 Hz.
- 8** - 10 to 30 Volt DC
- 9** - 90 to 130 Volt DC

**(4) Inner Fresnal Lens - Color**

- A** - Amber
- B** - Blue
- C** - Clear
- G** - Green
- R** - Red

**(5) Guard**

**G** - Cast guard  
 (omit "G" if guard not required)

**(6) Mounting Style**

- B2** - 3/4" npt. wall mount
- C2** - 3/4" npt. ceiling mount
- P2** - 3/4" npt. pendant mount
- S4** - 1 1/4" npt. stanchion mount



**(7) Special Options**

**SR**- Sealing ring for inverted mounting.  
 (must be used for globe up position to maintain  
 Type 3R enclosure / wet location listing)

**Note: Lamp is included**

**Consult factory for any catalog number  
 or options not listed above for price and  
 availability.**

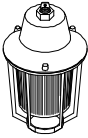
## Ordering Guide

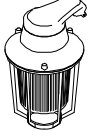
Lamp Type	Voltage	Hub Size	Pendant Mount 	Ceiling Mount 	Wall Mount 	Hub Size	Stanchion Mount 
Medium Intensity	120 V AC	3/4"	HXM 1R - G - P2	HXM 1R - G - C2	HXM 1R - G - B2	1 1/4"	HXM 1R - G - S4
	240 V AC	3/4"	HXM 2R - G - P2	HXM 2R - G - C2	HXM 2R - G - B2	1 1/4"	HXM 2R - G - S4
2 million candlepower	10-30 V DC	3/4"	HXM 8R - G - P2	HXM 8R - G - C2	HXM 8R - G - B2	1 1/4"	HXM 8R - G - S4
	90-130 V DC	3/4"	HXM 9R - G - P2	HXM 9R - G - C2	HXM 9R - G - B2	1 1/4"	HXM 9R - G - S4

**Ordering Notes:**

1. All catalog numbers shown are with red inner fresnal lens (see Catalog Number Logic for alternate colors).
2. All fixtures are shown with guard. To order fixture without guard, remove "G".

# HX-Strobe

## Dimensions

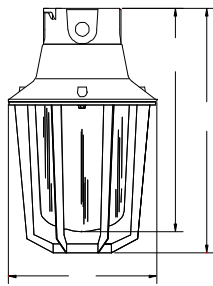

CEILING MOUNT

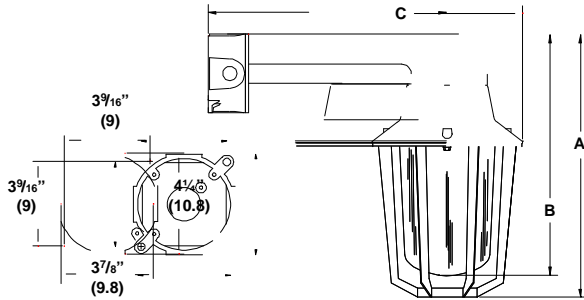

WALL MOUNT

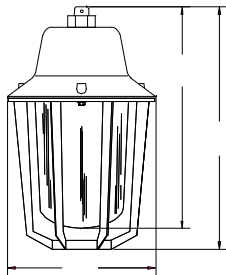

PENDANT MOUNT

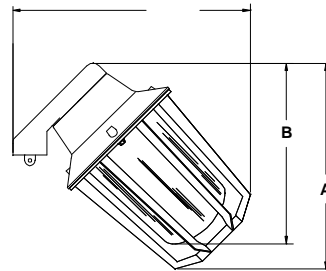

STANCHION MOUNT

Mount	A*	B*	C*	Weight **
Pendant	12.5 (31.8)	11.5 (29.2)	8 (20.3)	6.7 lbs. (3.0kg.)
Ceiling	13.25 (33.7)	12.25 (31.1)	8 (20.3)	8.9 lbs. (4.1 kg.)
Wall	14 (35.6)	13 (33.0)	13 (33.0)	10.9 lbs. (5.0 kg.)
Stanchion	12 (30.5)	11 (27.9)	13 (33.0)	8.3 lbs. (3.8 kg.)

**Notes:**

\* All dimensions are in inches (cm.)

\*\* Weights shown include cast guard, deduct 0.3 lbs.(0.13 kg.) if guard not required.







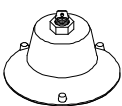

## Certification Guide (40°C Ambient)

Lamp Type	Class I, Div. 2 Groups A, B, C & D Temp Codes*	Type 3	Supply Wire Temp. (°C)
Medium Intensity	T2B	Yes	85

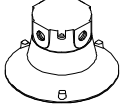
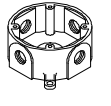
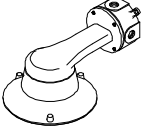
\* Temperature codes include globe and guard.

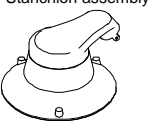
# HX-Strobe

## Components & Accessories

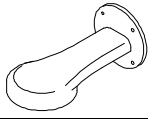
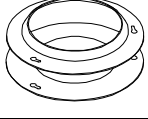
Mount & components	Hub Size	Catalog #	Weight lbs. (kg.)	Mount & components	Catalog #	Description	Weight lbs. (kg.)
Pendant 	3/4"	HXP2	1.8 lbs (0.8 kg.)		HXSB	Stanchion bracket	1.0 lbs (0.4)
Ceiling assembly 	3/4"	HXC2	4 lbs (1.8 kg.)		HXJB	Junction box	1.6lbs (0.64)
Wall assembly 	3/4"	HXB2	6 lbs (2.4 kg.)		HXR15	Prismatic glass globe	3.6 lbs (1.4)
Stanchion assembly 	1-1/4"	HXS4	4 lbs (1.8 kg.)		HXGG	Globe gasket	0.2 lbs (0.8)
Adapter housing 	--	HXAH	2.8 lbs (1.1)		GCM15	Cast guard	0.3 lbs (0.13)
Wall bracket 	--	HXWB	1.7 lbs (0.67)		ZXSR	Sealing ring kit (for globe up position mounting)	0.5 lbs (0.23)

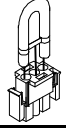
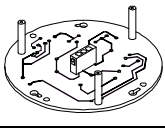
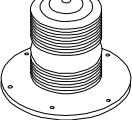
Strobe Components	Catalog #	Description	Weight lbs. (kg.)
	020-2011	Medium intensity flash tube (2 million candlepower)	0.1lbs (0.05)
Flashboard 	020-2001	Med. intensity 120 Volt AC, 50 / 60 Hz.	0.4 lbs (0.18)
	020-2003	Med. intensity 240 Volt AC, 50 / 60 Hz.	
	020-2008	Med. intensity 10 to 30 Volt DC	
	020-2010	Med. intensity 90 to 130 Volt DC	
	020-0210	Amber inner fresnel lens	0.2 lbs (0.1)
	020-0220	Blue inner fresnel lens	
	020-0230	Clear inner fresnel lens	
	020-0240	Green inner fresnel lens	
	020-0250	Red inner fresnel lens	